

汇流盒快速安装指南

Installation Guide-- Combiner Box-300A

1.简介 Introduction

该汇流盒适用于多台低压电池或多簇高压电池的汇流并联，系统最大允许电流 300A，低压电池电压一般是 40V~60V，高压电池一般是 180V~1000V。多台汇流盒可以继续并联，以扩展更大的系统容量。

The bushing box is suitable for the confluence and parallel connection of multiple low-voltage batteries or multiple clusters of high-voltage batteries. The maximum allowable electric current of the system is 300A. Generally a low-voltage battery ranges from 40V to 60V, and a high-voltage battery ranges from 180V to 1000V. Then the multiple combiner box can still be connected in parallel to expand larger capacity of system.

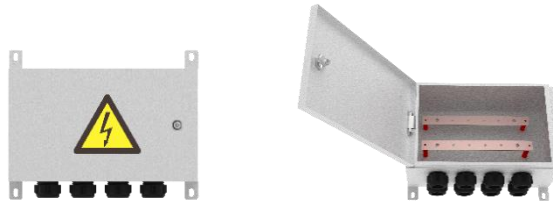

系统原理示意图如下所示：

The schematic diagram of the system is as follow:

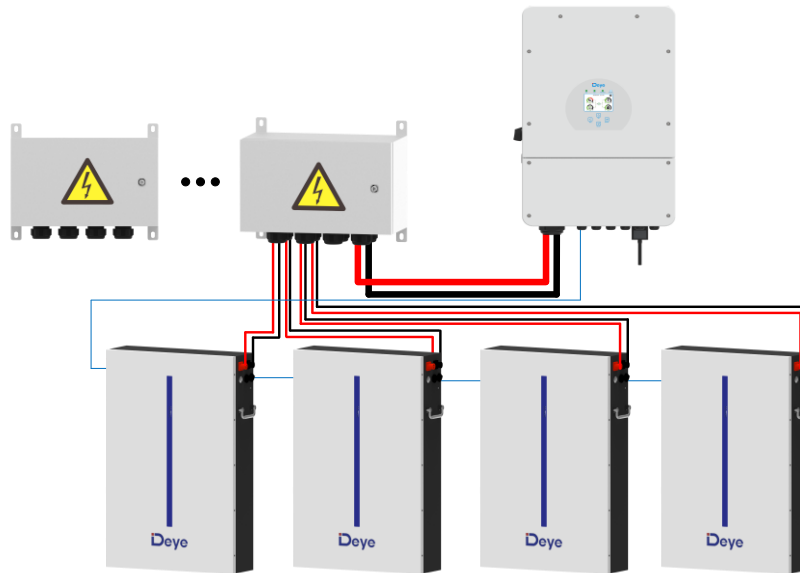

2.尺寸及接口 Dimensions and Interfaces

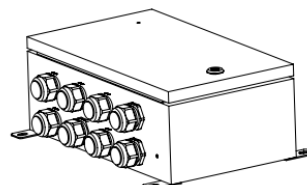
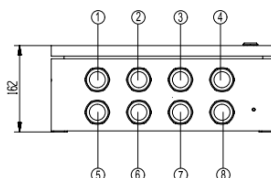
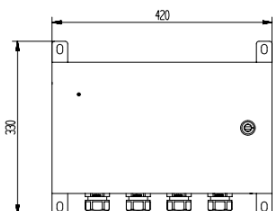

NO.	Port	Description
1 or 4	+ 输出 output	<p>电池总正极输出口，接入逆变器或接入下一台汇流盒</p> <p>Output interface of the total positive of the battery , which can be connected to inverters or another bushing box.</p>
2, 3, 6, 7	电池输入 input	<p>电池正负极输入接口</p> <p>Input interface of positive and negative poles of the battery.</p>
5 or 8	- 输出 Output	<p>电池总负极输出口，接入逆变器或接入下一台汇流盒</p> <p>Output interface of the total negative of the battery, which can be connected to inverters or another bushing box.</p>

3.安装准备 Installation preparation

3.1 检查装箱清单 Check the packing list

打开包装后，根据以下列图示检查材料和配件是否齐全。

After opening the package, check the materials and accessories as per the

list of packing as below.

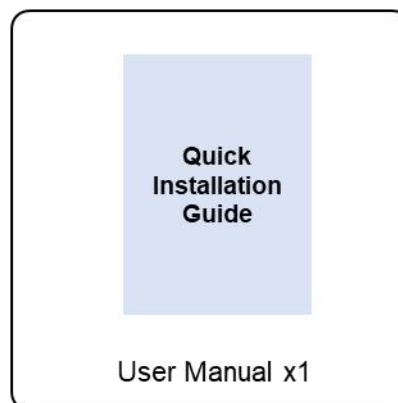
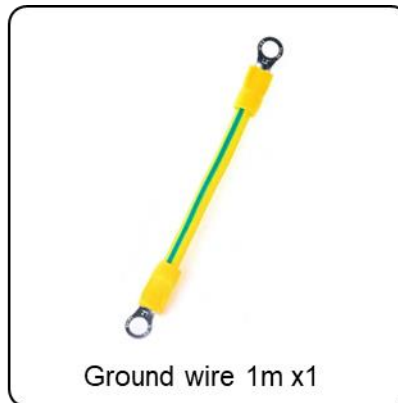
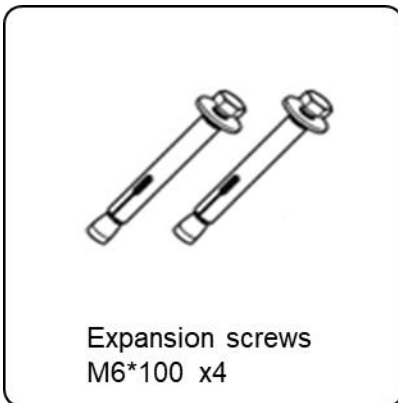

3.2 工具准备 Tool Preparation

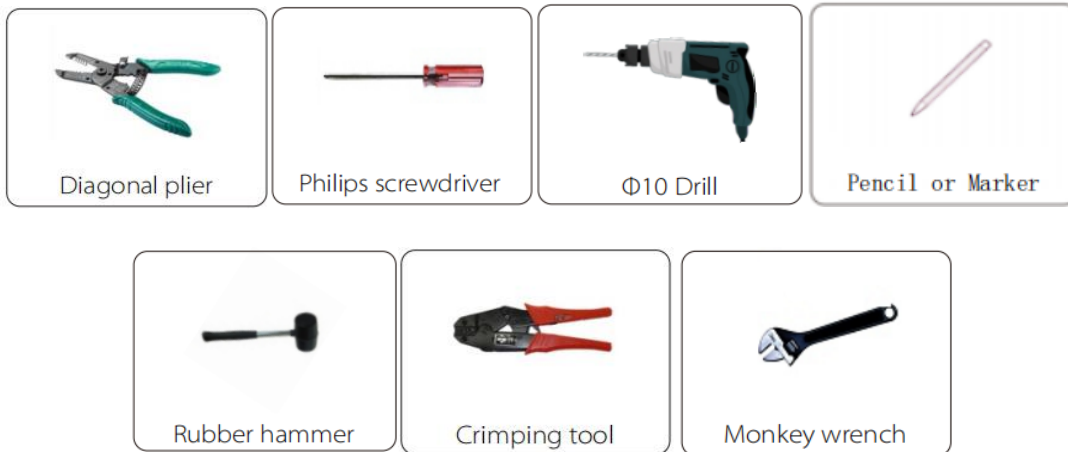

4.安装步骤 Installation Steps

第 1 步: 将汇流盒放在预安装的位置, 使用铅笔或马克笔在 4 个固定孔位置做好标记, 然后使用 Φ10mm 钻头在标记位置壁上钻孔, 钻孔深度 100mm-110mm。孔位置如下图所示, 单位: 毫米。

Step 1: Place the bushing box at the pre-installation position. Use a pencil or marker pen to mark the four holes and drill holes in the marked location using a Φ10mm bit, the drilling depth is 100mm-110mm. The hole locations are shown in the following figure, unit of measurement: mm.

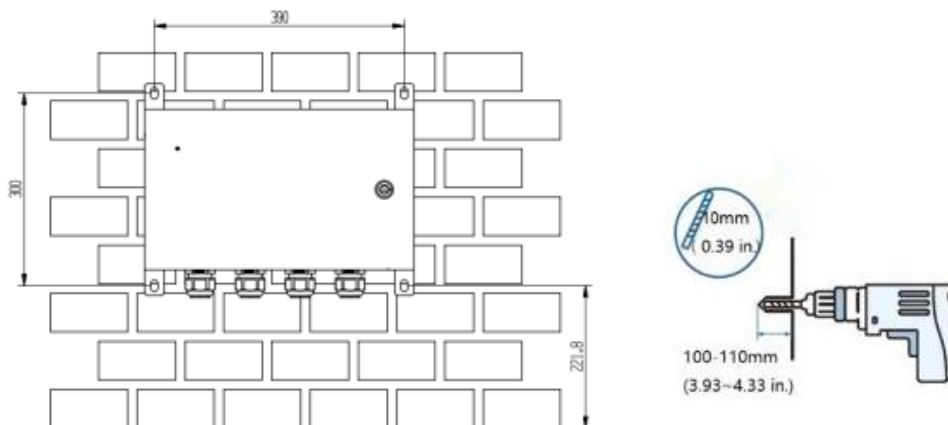

第 2 步: 将汇流盒放在打孔位置, 插入 4 根膨胀螺丝 (M6*100) , 然后将螺丝拧紧, 最大 5N.m。

Step 2: Place the bushing box in the punch position, insert 4 expansion screws (M6*100) ,and

tighten the screw to a maximum torsion of 5N.m

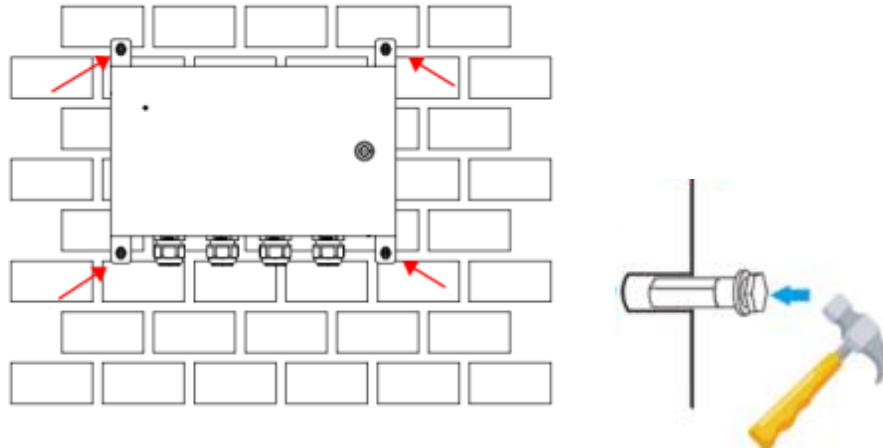

5.技术参数 Technical Data Sheet

型号 Model	Combiner Box-300A
电池输入 Battery Input	
电池电压范围 Battery voltage range [V]	最大 1000, MAX. 1000
电池输入数量 Number of Battery Input	4 (M8 螺丝 M8 screws)
电池输出数量 Number of Battery Output	2 (M10 螺丝 M10 screws)
最大工作电流 Max. Operating current [A]	300A
工作环境 Environment Limit	
防护等级 IP Rating of Enclosure	IP55
工作温度范围 Operating temperature range [°C]	-40 ~ +60 (>45°C 降额 derating)
冷却方式 Cooling	自然冷却 Nature cooling
储存温度范围 Storage temperature [°C]	-40 ~ +80
相对湿度 Relative humidity [%]	0 ~ 95 (无冷凝 non-condensing)
海拔 Altitude[m]	< 3000
尺寸和重量 Dimension and Weight	
尺寸 Dimension (宽深高 W x D x H,mm)	420 x 200 x 250
重量 Weight (kg)	15